



Quick Quicker *Ather*

Introducing the new **450 Series**



450 

2.9 kWh Battery
Power play. Every day.

—

0-40 km/h in
3.9 sec

Top Speed
90 km/h

450 

2.9 kWh & 3.7 kWh Battery
More thrills. Per second.

—

0-40 km/h in
3.3 sec

Top Speed
90 km/h

Designed for *performance*

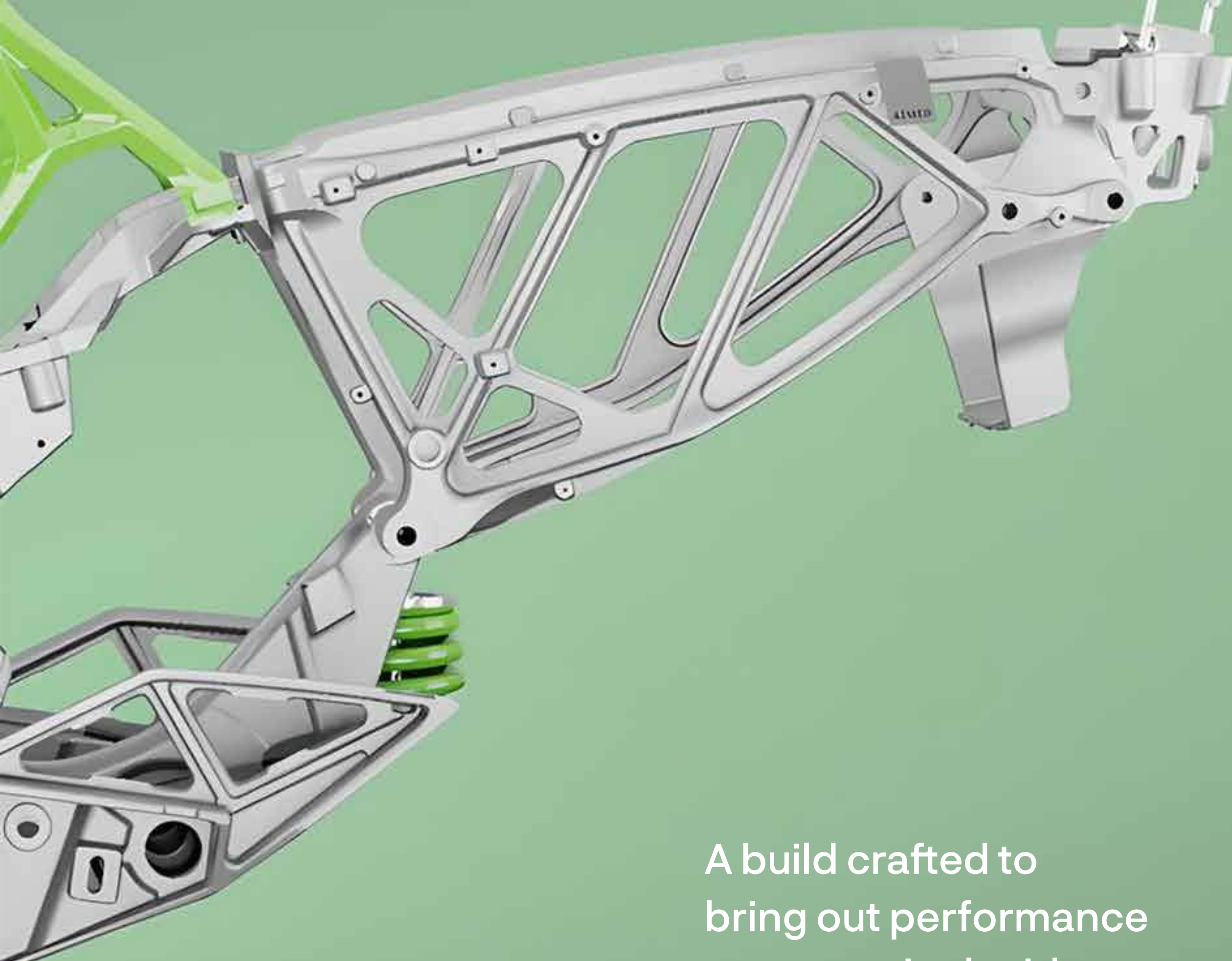

A build crafted to bring out performance on every single ride.

- Lightweight, heavy-duty hybrid aluminium chassis
- Low center of gravity for superior ride handling
- Better stability with rear monoshock suspension
- MRF Zapper Tyres for greater grip in any weather

More power to you

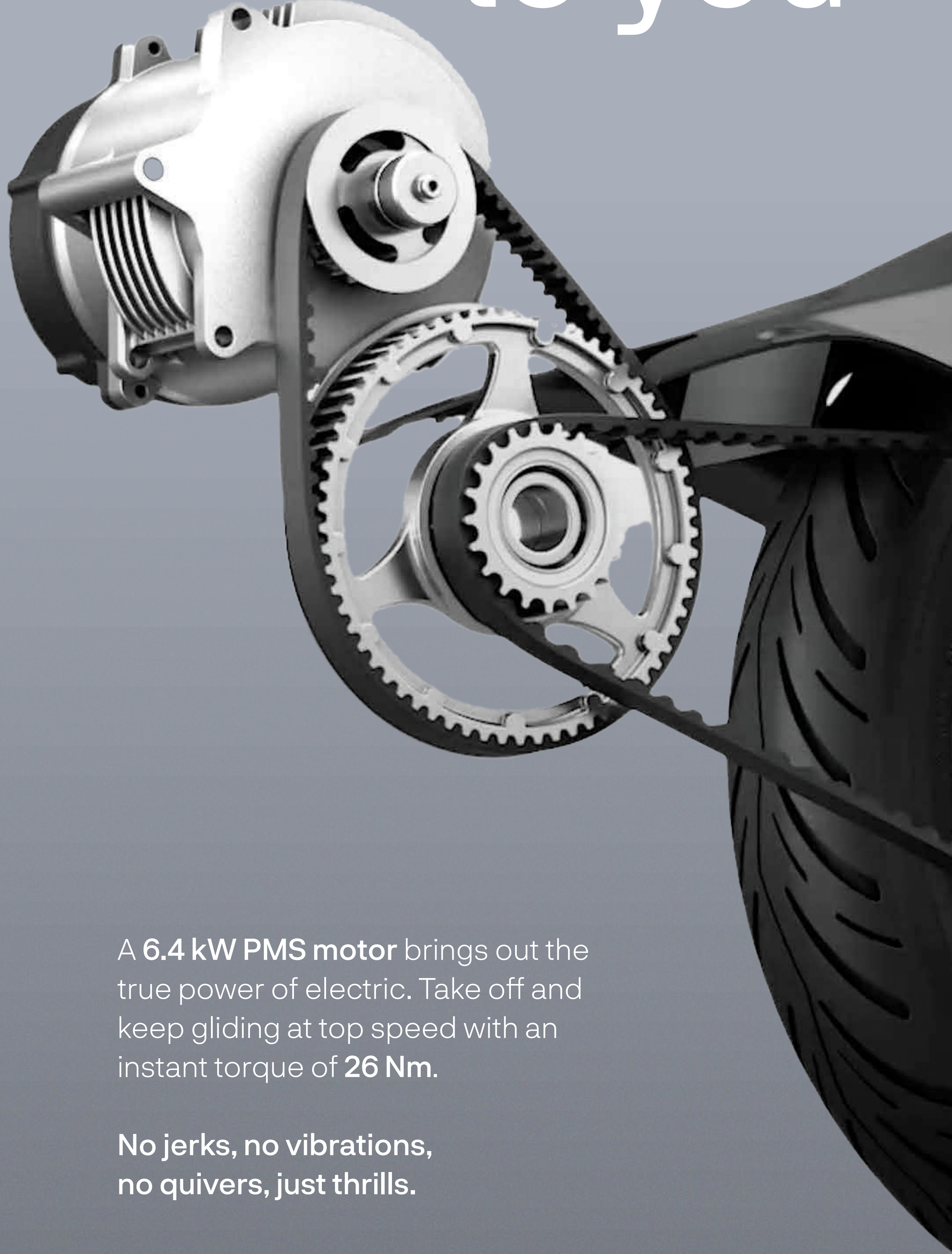

A **6.4 kW PMS motor** brings out the true power of electric. Take off and keep gliding at top speed with an instant torque of **26 Nm**.

No jerks, no vibrations, no quivers, just thrills.

A battery that does *brilliantly*



Stronger, lighter, better

Pressure die-cast aluminium casing

Water & dust resistant

IP67 rated

Ather Battery Protect™

- 5 years or 60,000 km warranty
- Minimum 70% State-of-Health for 5 years
- No upper limit on claims
- Deep discharge protection
- 100% coverage against defects or failures

A dash of intelligence



450X

Industry First
Touchscreen
Dashboard
17.7 cm (7")

- Google Maps
- Bluetooth: Call & Music Control
- OTA Updates
- Interactive UI
- TrueRange™: Intelligent Range Prediction
- Document Storage
- Incognito Mode



450X

Industry First
DeepView™ Display
17.7 cm (7")

- Turn-by-turn Navigation
- Bluetooth: Call & Music Control
- OTA Updates
- Interactive UI
- TrueRange™: Intelligent Range Prediction

One app for everything

Ather

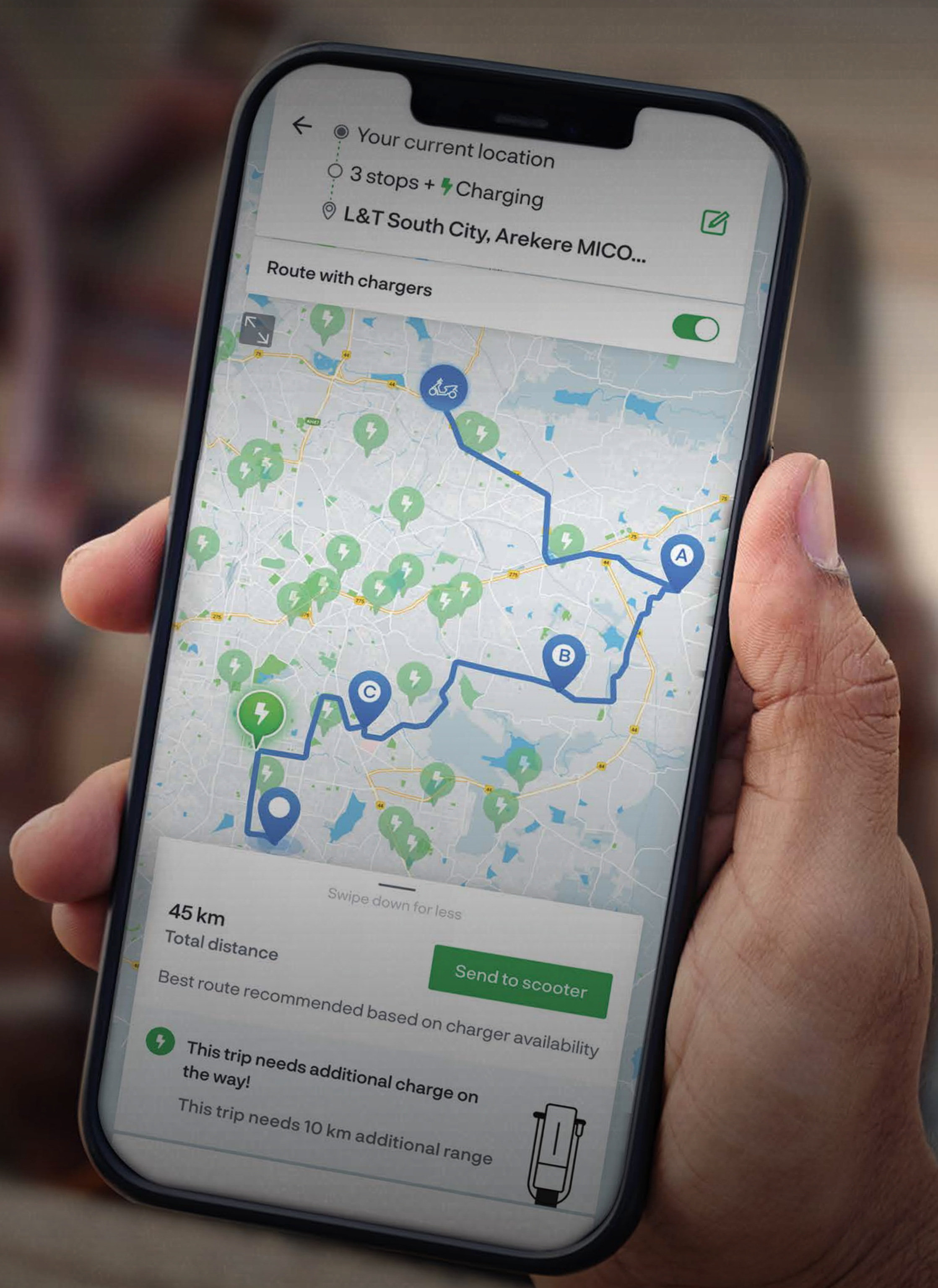

Connectivity
in the palm of
your hands

- Theft & tow alerts
- Find my scooter
- Push Navigation
- Savings tracker
- *Document Storage
- *Inter-city Trip Planner™

*Exclusively for 450X

Convenience comes easy



> Autohold™ Hands-free braking on slopes

> 22L Under Seat Storage

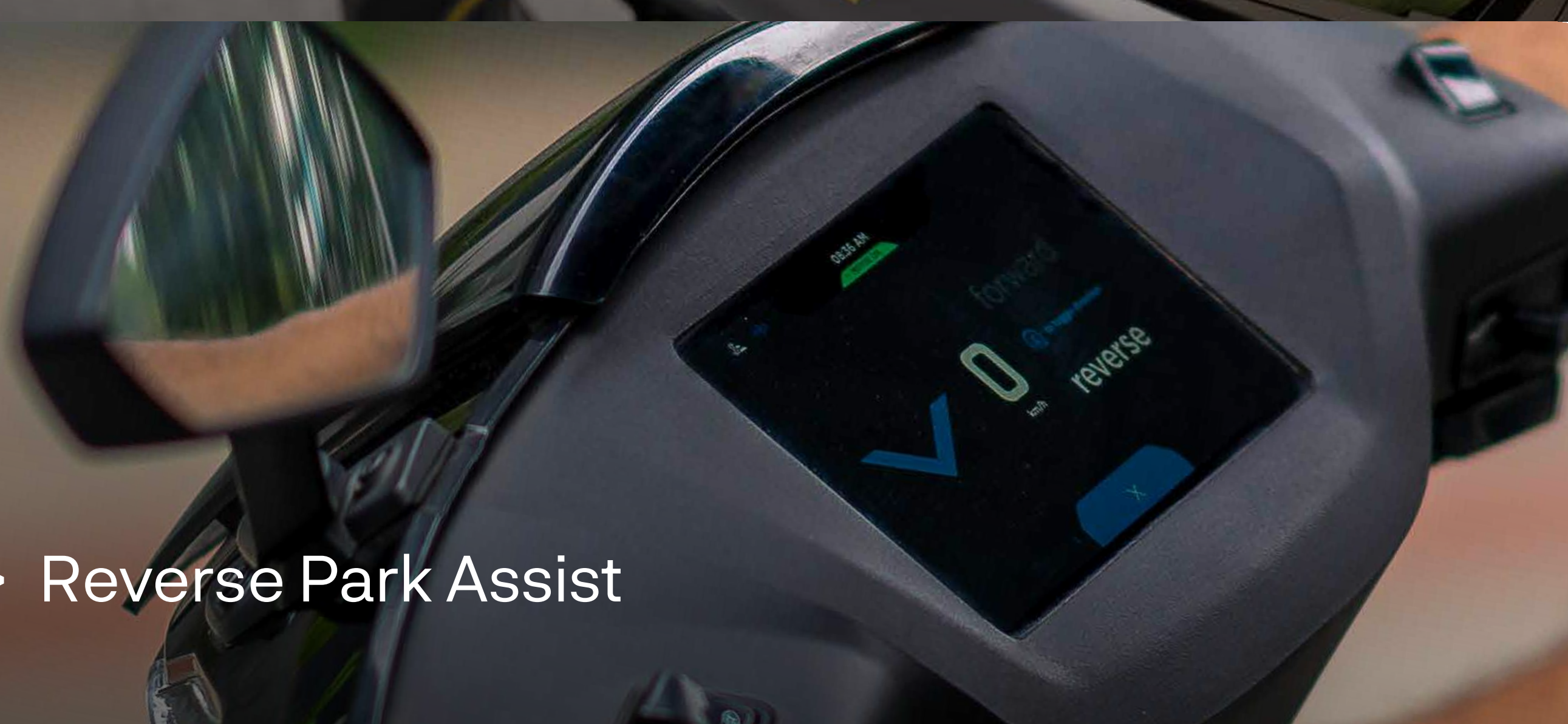

> Reverse Park Assist

> Side Step

> Auto Indicator
Cut-off

> Frunk™ (Front storage)

> Guide-me-home
lights

Safety first, second and third

**Emergency
Stop Signal**

Panic braking will automatically trigger tail light flashing, warning everyone of an emergency situation.

FallSafe™

In case of a fall, your Ather will immediately detect it and cut off the motor, protecting you from further danger.

Dual Disc Brakes

60 - 0 km/h in <2 seconds

Flying colours.

Now on the road.

- True Red*
- Salt Green
- Lunar Grey*
- Cosmic Black
- Still White
- Space Grey



*Exclusively for 450X

Stay in charge whenever, wherever



1400+ Ather Grid™ points

India's largest & fastest growing charging network

Ather Portable Charger

Plugs into any 5A socket whether at home or away

Top up your experience with Ather Accessories

Ather Helmets

Head to wheels, colour coordinated.

Ather TPMS (Tyre Pressure Monitoring System)

Low or high, it tells you when the tyre pressure isn't right.

Ather Side Step

There when you need it. Invisible when you don't.

Ather Frunk™

Store. Much more. On-the-go.



Ather Essentials

The must-have kit to keep your ride protected and looking new for longer.

> Ather BodyGuard

Catches all scratches before they hit your scooter.

> Floor Mats

Put your foot down against dirt-ridden floors. Fits perfectly, cleans easily.

> Seat Covers

Just wear and don't worry about tear.

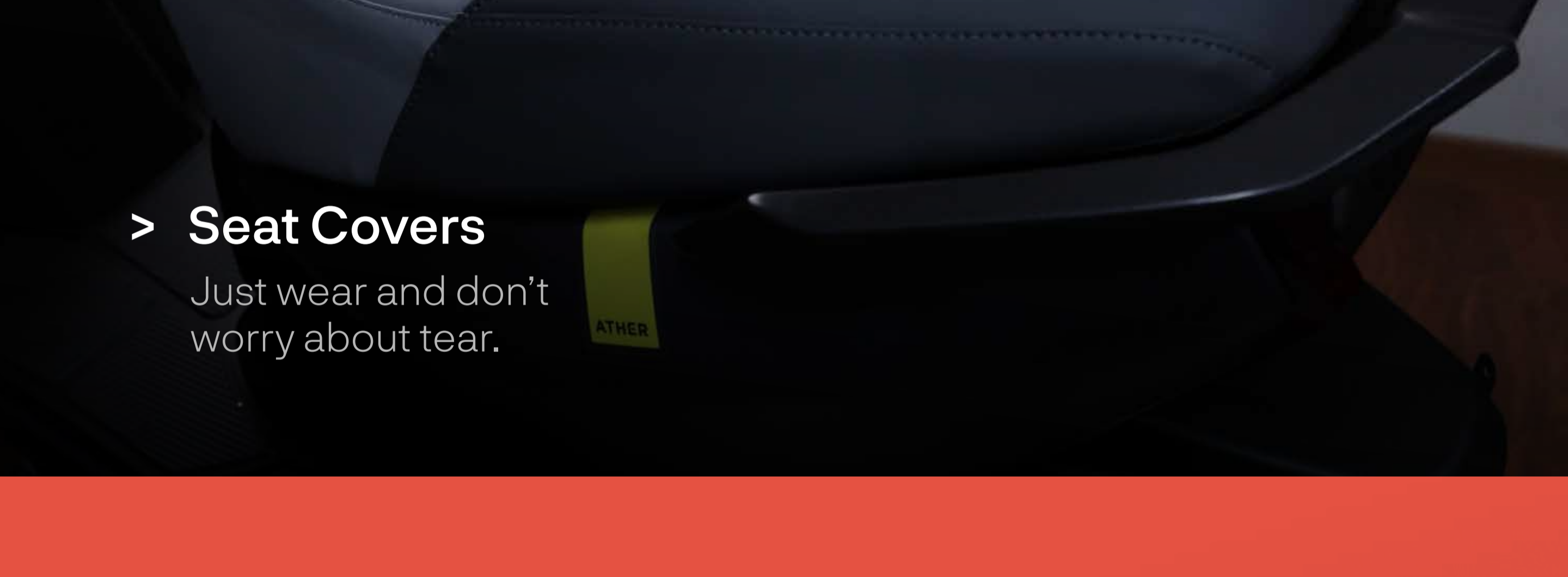
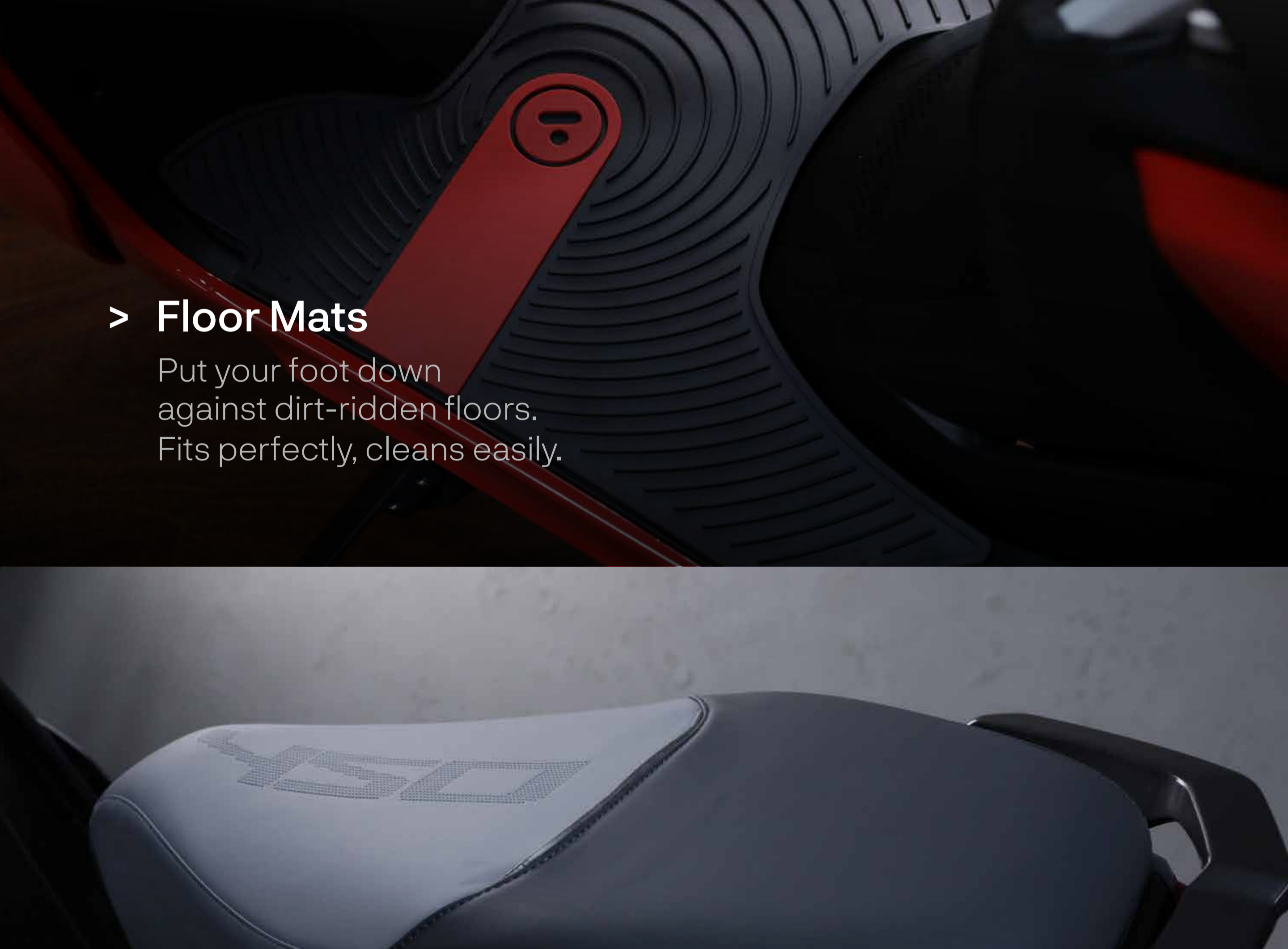

Made of Ather Merchandise



Scan the QR code for more designs

Find out what it's really like to own an Ather

Head to the Ather Forum™

Read unbiased product reviews and find answers to all your questions on our online community.

forum.atherenergy.com

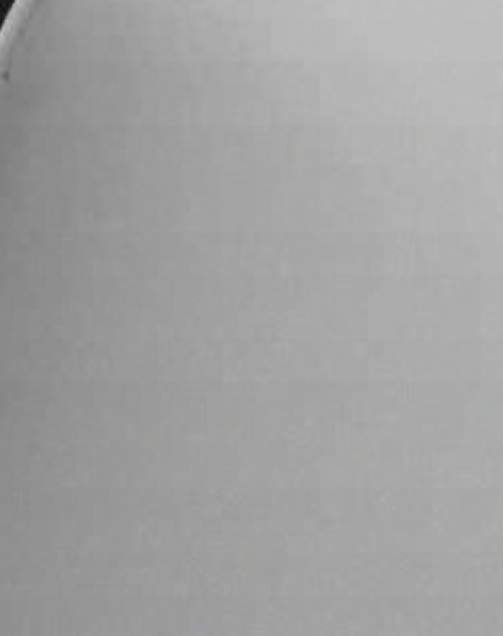
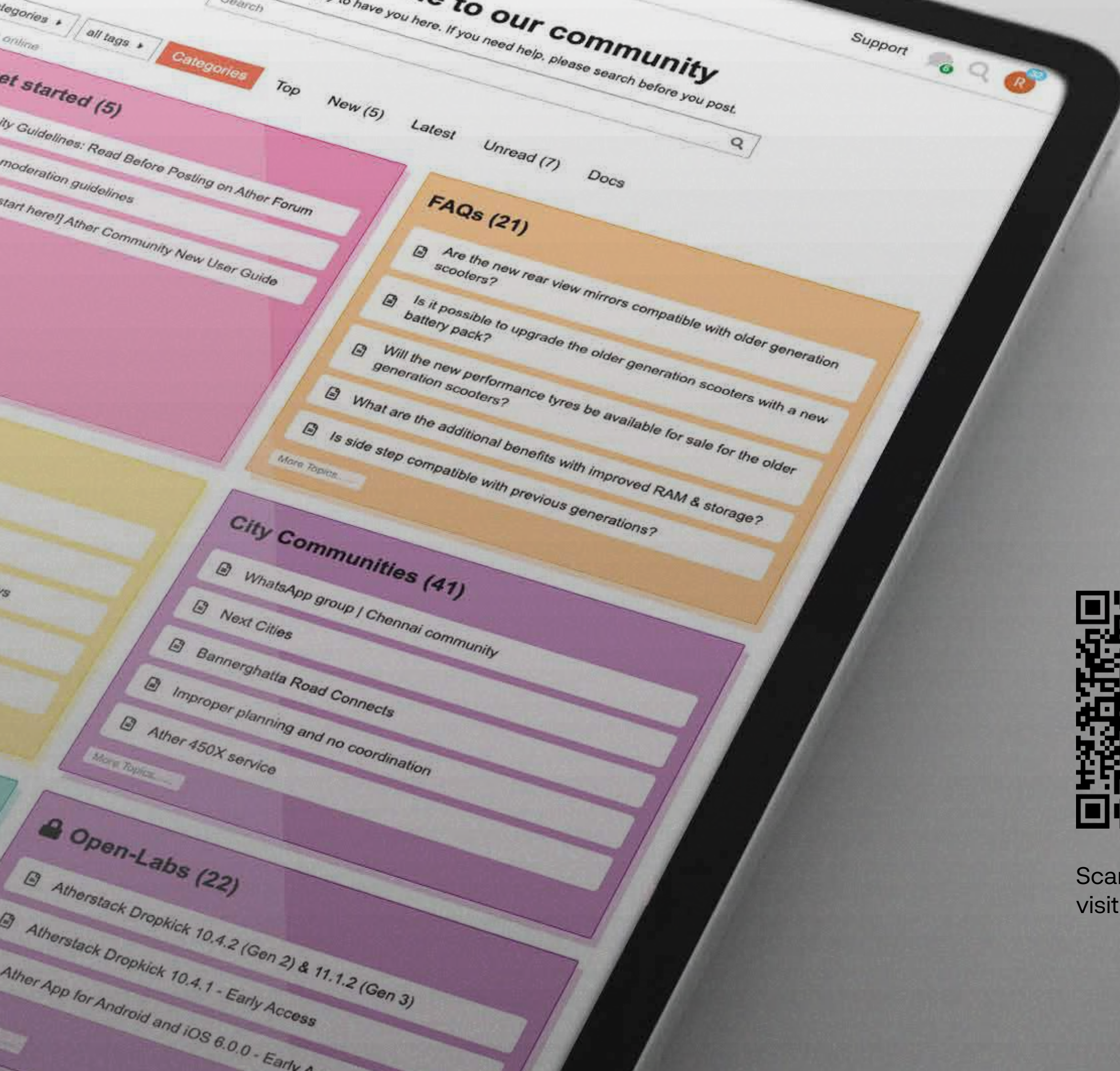

Scan the QR code to visit the Ather Forum™

Specifications & features



2.9kWh Battery



2.9kWh Battery



3.7kWh Battery

Performance

Power (peak)	5.4 kW	6.4 kW	6.4 kW
Max torque	22 Nm	26 Nm	26 Nm
Top speed	90 km/h	90 km/h	90 km/h
Acceleration (0-40 km/h)	3.9 s	3.3 s	3.3 s
Gradeability at peak power	18 degrees	20 degrees	20 degrees
Motor type	PMSM	PMSM	PMSM
Ingress protection (motor)	IP66	IP66	IP66
Ingress protection (controller)	IP65	IP65	IP65

Range

Certified Range*	115 km	111 km	150 km*
------------------	--------	--------	---------

Battery

Installed capacity	2.9 kWh	2.9 kWh	3.7 kWh
Battery type	Lithium-ion	Lithium-ion	Lithium-ion
Nominal voltage	51.1V	51.1V	51.1V
Water & dust resistance	IP67	IP67	IP67
Pack casing	Aluminium alloy	Aluminium alloy	Aluminium alloy

Charging

Home Charging*			
0-80%	6 hr 36 min	6 hr 36 min	4 hr 30 min
0-100%	8 hr 36 min	8 hr 36 min	5 hr 45 min
Ather Grid™ access	Yes	Yes	Yes
0-50% SOC	1.5 km/min	1.5 km/min	1.5 km/min
50-80% SOC	1 km/min	1 km/min	1 km/min

Tyres & wheels

Wheel type	Alloy wheels	Alloy wheels	Alloy wheels
Wheel size (front)	30.4 cm x 5.4 cm (12"x 2.15")	30.4 cm x 5.4 cm (12"x 2.15")	30.4 cm x 5.4 cm (12"x 2.15")
Wheel size (rear)	30.4 cm x 6.3 cm (12"x 2.5")	30.4 cm x 6.3 cm (12"x 2.5")	30.4 cm x 6.3 cm (12"x 2.5")
Tyre size (front)	90/90-12 tubeless tyres	90/90-12 tubeless tyres	90/90-12 tubeless tyres
Tyre size (rear)	90/90-12 tubeless tyres	100/80-12 tubeless tyres	100/80-12 tubeless tyres

Brakes

Braking system	Combined braking system & regenerative braking		
Brake type (front)	Hydraulically actuated triple-piston calliper disc		
Brake type (rear)	Hydraulically actuated single-piston calliper disc		
Disc size (front)	20 cm		
Disc size (rear)	19 cm		
Braking distance (60-0 km/h)	28.6 m		

Transmission

Type	Belt drive		
Transmission ratio	7.8:1		

Suspension & frame

Front suspension	Telescopic forks		
Rear suspension	Symmetrically mounted progressive monoshock		
Frame type	Precision machined hybrid chassis		
Frame materials	Aluminium and steel		

Peripherals & convenience

Headlights	LED		
Tailights	LED		
Indicators	LED		
Park Assist™	Yes		
Side stand motor cut-off	Yes		
Boot storage	22L		
Pillion grab handle	Aluminium		

Dimensions & storage

Length	189.1 cm	189.1 cm	189.1 cm
Width	73.9 cm	73.9 cm	73.9 cm
Height	111.4 cm	111.4 cm	111.4 cm
Wheelbase	129.6 cm	129.6 cm	129.6 cm
Ground clearance	17 cm	17 cm	17 cm
Seat height	78 cm	78 cm	78 cm
Kerb weight	108 kg	108 kg	111.6 kg
F:R weight ratio	48:52	48:52	48:52
Water wading limit	30 cm	30 cm	30 cm

Dashboard

Processor	Snapdragon 212 Quadcore 800Mhz	Snapdragon 212 Quadcore 1.3Ghz	Snapdragon 212 Quadcore 1.3Ghz
Storage	8GB	16GB	16GB
RAM	1GB	2GB	2GB
Operating system	Android Open Source OS (AOSP)	Android Open Source OS (AOSP)	Android Open Source OS (AOSP)
Screen size & type	17.7 cm (7") DeepView™ Display	17.7 cm (7") TFT touchscreen	17.7 cm (7") TFT touchscreen
Touchscreen type	-	Capacitive	Capacitive
Resolution	-	800 x 480 pixels	800 x 480 pixels
Colours	-	16M	16M
Brightness	500 Nits	800 Nits	800 Nits
Aspect ratio	5:3	5:3	5:3
Water & dust resistance	IP65	IP65	IP65

Colours

	Space Grey, Still White, Salt Green, Cosmic Black	Space Grey, Still White, Salt Green, True Red, Cosmic Black, Lunar Grey™	Space Grey, Still White, Salt Green, True Red, Cosmic Black, Lunar Grey™
--	--	--	--

Warranty

Vehicle warranty	3 years/30,000 km whichever is earlier		
Charger warranty	3 years		
Battery warranty	3 years/30,000 km whichever is earlier		

Unlock all the smarts, all the intelligence, with

Bundle in Pro* with your scooter at the time of purchase to get a sweetened deal.

RideAssist™

Riding modes	4	5	5
TrueRange™ Display	SmartEco™ - 90 km Eco - 85 km Ride - 75 km Sport - 70 km	SmartEco™ - 90 km Eco - 85 km Ride - 75 km Sport - 70 km Warp™ - 60 km	SmartEco™ - 110 km Eco - 105 km Ride - 90 km Sport - 85 km Warp™ - 75 km
Interactive UI	Yes	Yes	Yes
Dashboard auto brightness	Yes	Yes	Yes
AutoHold™	Yes	Yes	Yes
Auto Indicator cut-off	Yes	Yes	Yes
Guide-me-home lights	Yes	Yes	Yes
Vehicle FallSafe™	Yes	Yes	Yes
Coasting Regen	Yes	Yes	Yes
Emergency Stop Signal (ESS)†	Yes	Yes	Yes
Call & Music control	Yes	Yes	Yes

Ather Connect™

Complimentary for 3 years

Navigation	Turn by turn	Google Maps	Google Maps
Document Storage	-	Yes	Yes
Ather App™ features	Yes	Yes	Yes
Tow & Theft Notifications	Yes	Yes	Yes
Find my scooter	Yes	Yes	Yes
Ride Stats	Yes	Yes	Yes
Push Navigation	Yes	Yes	Yes
Inter-city Trip Planner™	-	Yes	Yes
Savings trackers	Yes	Yes	Yes
Ather Labs™	Yes	Yes	Yes

Atherstack™

OTA Updates	Yes	Yes	Yes
-------------	-----	-----	-----

Ather Battery

Protect™ 5 years or 60,000 km whichever is earlier	Yes†	Yes†	Yes
--	------	------	-----

www.atherenergy.com

T&C apply. Ather Energy's trademarks are listed at <https://atherenergy.com/trademarks>. *Declared certified range figures are as per ARAI/DC standard testing conditions, actual performance figures may vary depending on various conditions including driving patterns etc. †Subject to Certification. ‡Home charging figures are as per ideal conditions. †Pro is a bundle of smarts, intelligence and ownership products, it can be bought until 24 months from the date of purchase of the scooter. ‡ESS feature will be released as an OTA update. †Ather Battery Protect is available as an optional purchase along with Pro pack only for 450S & 450V (2.9kWh). All third party trademarks including words, logos and icons referenced by Ather Energy Private Limited remain the property of their respective owners.

©2023 Ather Energy. All rights reserved.



www.atherenergy.com